

KOMATSU

D65EX-18
D65EXi-18
D65PX-18
D65PXi-18
D65WX-18
Tier 4 Final Engine

CRAWLER DOZER



intelligent / **2.0**
MACHINE CONTROL

Photos may include optional equipment.

NET HORSEPOWER

217 HP @ 1950 rpm
162 kW @ 1950 rpm

OPERATING WEIGHT

SIGMADOZER® / Semi-u
D65EX-18: 46,892 lb 21270 kg
D65EXi-18: 46,892 lb 21270 kg
D65WX-18: 50,618 lb 22960 kg

Straight Tilt Dozer

D65PX-18: 50,331 lb 22830 kg
D65PXi-18: 50,331 lb 22830 kg

BLADE CAPACITY

SIGMADOZER® / Semi-u
D65EX-18: 7.3 yd³ 5.6 m³
D65EXi-18: 7.3 yd³ 5.6 m³
D65WX-18: 7.7 yd³ 5.9 m³

Straight Tilt Dozer

D65PX-18: 4.8 yd³ 3.7 m³
D65PXi-18: 4.8 yd³ 3.7 m³

D65 / D65i

WALK-AROUND

Next-generation intelligence

Enhanced machine efficiency for work ranging from heavy dozing to finish grading with intelligent Machine Control technologies.

Lift layer control

Achieves consistent lift layers with automatic control.

Quick surface creation

Creates a temporary design surface with the press of a button.

Proactive dozing control

Cut and carry work performed with the smoothness of an experienced operator.

Tilt steering control

Reduces need for constant operator corrections toward target point.

Two antennas to support multiple global navigation satellite system (GNSS)

Improved satellite signal stability and reception offer more reliability and accuracy.

Factory installed information and communication technology (ICT) system standard



NET HORSEPOWER

217 HP @ 1950 rpm
162 kW @ 1950 rpm

OPERATING WEIGHT

SIGMADOZER® / Semi-u
D65EX-18: 46,892 lb 21270 kg
D65EXi-18: 46,892 lb 21270 kg
D65WX-18: 50,618 lb 22960 kg

Straight Tilt Dozer

D65PX-18: 50,331 lb 22830 kg
D65PXi-18: 50,331 lb 22830 kg

BLADE CAPACITY

SIGMADOZER® / Semi-u
D65EX-18: 7.3 yd³ 5.6 m³
D65EXi-18: 7.3 yd³ 5.6 m³
D65WX-18: 7.7 yd³ 5.9 m³

Straight Tilt Dozer

D65PX-18: 4.8 yd³ 3.7 m³
D65PXi-18: 4.8 yd³ 3.7 m³

Photos may include optional equipment.

D65EX/EXi/PX/PXi/WX-18

INNOVATIVE. INTEGRATED. INTELLIGENT.



Standard intelligent Machine Control 2.0
Standard factory-installed integrated 3D
GNSS intelligent machine control system.

Improved Machine Control
Uses data from previous pass to plan the next pass. Helps new operators perform like experienced operators.

Factory Installed Machine Control Components

Machine control components are factory installed and designed as an integral part of the base machine for improved durability.

Komatsu Quality

Machine control components and system validated to Komatsu's rigorous quality & durability standards.

Industry Standard Compatibility

Machine control system makes use of common industry design data file norms and supports typical base station communication.

Simple Operator Interface

Simple touch screen control box with multi-color customizable display.

3D GNSS Machine Control Standard

All on-machine components standard including control box, GNSS receiver/radio, GNSS antenna, and enhanced inertial measuring unit sensor.

Finish Grade Performance

Enhanced sensor package and intelligent logic provides for finish grade accuracy in an integrated system without traditional blade mounted sensors.

Enhanced Inertial Measuring Unit (IMU+)

Chassis mounted enhanced inertial measuring unit (IMU+) and intelligent logic provides for finish grade accuracy without blade mounted sensors.

Dual Cab Top GNSS Antennas

Load control intelligence controls blade elevation to improve productivity and minimize track slip by adjusting blade load. 1.0' from grade or 0.1' from grade – you can run in auto mode.

Intelligent Dozing Mode Settings

Operators are able to select between 4 distinct machine control operating modes to optimize performance to the application whether cutting, spreading, or other.

Operator Selectable Load Settings

Machine control load settings can be adjusted between presets to tailor response to material conditions.

SAA6D114E-6 diesel engine provides excellent fuel economy. This engine is EPA Tier 4 Final emissions certified.

Variable Geometry Turbocharger (VGT) uses a hydraulic actuator to provide optimum air flow under all speed and load conditions.

Includes a wide core A/C condenser and bowl-type precleaner on the cab air intake for improved performance in high debris applications.

Komatsu Diesel Particulate Filter (KDPF) and Selective Catalytic Reduction (SCR) systems reduce particulate matter and NOx, while providing automatic regeneration that does not interfere with daily operation.

Auto Engine Idle reduces machine to low idle during times of inactivity.

Large color monitor:

- Easy-to-read and use large seven inch high-resolution multi-color monitor
- Ecology guidance
- On-board diagnostics

Rearview Monitoring System (standard) displays the area behind the machine onto the wide landscape view color monitor screen.

Integrated ROPS cab features include:

- Large, quiet, and pressurized cab meets ISO 3471 standard
- Improved visibility with integrated ROPS structure
- Heated air-suspension seat with high capacity
- Aux plug for audio player and two 12-volt connections
- New LED worklights
- New Bluetooth/USB compatible radio

Torqflow transmission with 4 shift modes improves fuel economy and productivity:

- Auto shift, torque converter lockup ON
- Auto shift, torque converter lockup OFF
- Manual shift, auto-downshift ON
- Manual shift, auto-downshift OFF

The selected mode remains saved in the monitor at engine key-off/key-on.

Hydrostatic Steering System (HSS) has 25% more power for improved turning and counter-rotation.

Maintenance Free Batteries

Battery Disconnect Switch with lockout/tagout
Eliminates power draw during storage.

INTELLIGENT MACHINE CONTROL



intelligent Machine Control (iMC) 2.0

D65EXi/PXi-18 utilizes intelligent Machine Control 2.0 a GNSS* system that automatically controls the blade to 3-dimensional design data. Machine Control 2.0 utilizes the industry's first Proactive Dozing Control logic, lift layer control, quick surface creation, and tilt steering control. A two-antenna system supporting multiple GNSS, which provides less downtime and more work time. These added features make for improved production and efficiency.

*GNSS (Global Navigation Satellite System): General term for satellite positioning systems such as GPS, GLONASS, etc.

Quick surface creation

Operators can create a temporary design surface with the press of a button. Designed to simplify in-field surface creation within the control box, it allows for more utilization of iMC 2.0.



Tilt steering control

The blade automatically tilts under a heavy load to maintain a straight line of travel, optimizing productivity throughout each pass and reducing operator fatigue.



Auto/manual switch

A conveniently located on/off switch giving the operator control of when iMC 2.0 is active.



Function switches

Cut/fill offset switch

The target surface height can be quickly adjusted by pressing the offset switch (button).

Back grade mode switch

Allows for automatic control during back grading.

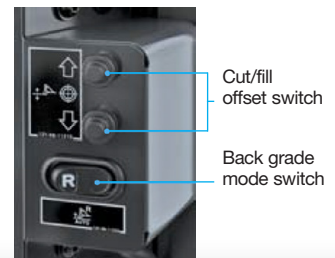



Lift layer control

Optimize earthwork productivity and maintain compaction quality by automatically controlling lifts to the desired heights with respect to the mapped terrain. Excess fill is eliminated as automatic blade control will follow finish surface once lifts have reached finish grade.

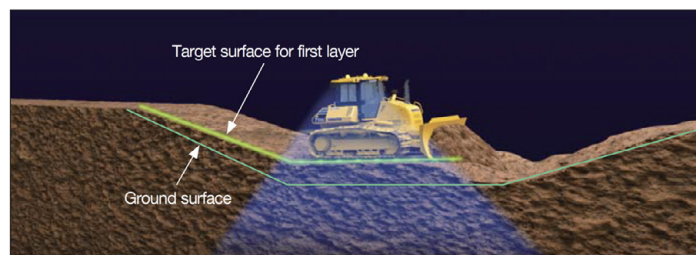

Proactive dozing control

Operators can utilize automatic blade control from rough grading to finish grading work. Proactive dozing control understands the terrain in the path of each cut, maximizes the blade load throughout the pass, regardless of the terrain ahead, and achieves productivity similar to that of an experienced operator.

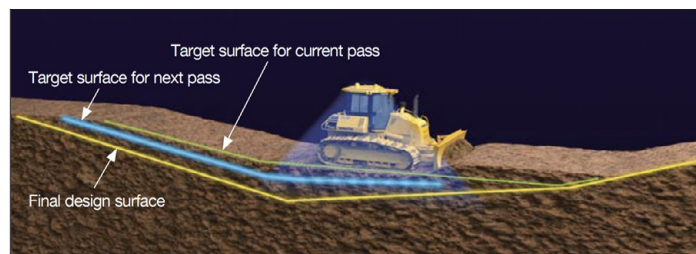

Two antennas supporting multiple GNSS

Work accuracy is improved by two antennas supporting the multiple GNSS.

Improvement of blade accuracy on slope

Blade accuracy is maintained during slope work.

Reliability of blade accuracy

Galileo, QZSS, and BeiDou can be used in addition to GPS and GLONASS. Since the satellite capture rate is improved, the machine can be used in any time zone.



Control box

- 1 L.H. LED indicator 2 Upper LED indicator
- 3 R.H. LED indicator
- 4 Power ON/OFF and menu switch (Press: Display the main menu / Hold down: Turn ON/OFF the power supply)
- 5 Zoom in switch 6 Zoom out switch
- 7 Toggle main view switch (Press: Switch the display of main window / Hold down: Adjust the brightness and sound volume)
- 1 Left window 2 Main window 3 Lower window
- 4 Right window 5 Speed control ON/OFF
- 6 Take a topo shot 7 Simple grading ON/OFF
- 8 Cut depth selection 9 Smooth start ON/OFF
- 10 Tilt steering ON/OFF 11 Toggle As-built mode change view to [none], [cut fill], [pass counts]
- 12 Quick surface creation (Create slope plane surface)
- 13 Lift layer control (Create As-built design surface)
- 1 Elevation control key 2 Slope control key
- 3 GNSS status 4 Radio status 5 Cut/Fill offset
- 6 Cut/Fill reading 7 Tilt of blade
- 8 Design cross-slope 9 Type of control
- 10 AUTO indicator 11 Back Grade mode indicator
- 12 Lift indicator

*This is a typical main screen of control box.



iNTELLIGENT MACHINE CONTROL

Automatic dozing from grass to grade

Benefits of iMC 2.0



Improved finish grading

Applications: Finish grading

- Analyzes terrain and 3D model to proactively position blade in hard-to-grade areas
- Helps prevent overcutting at finish grade



Lift layer control

Applications: Lifting, compaction quality control

- Maintain precise lift thickness
- Automatically spreads lift from existing terrain and helps prevent overfill
- Up to double the production of prior model



Proactive dozing control

Applications: Stripping topsoil, high-production dozing

- Uses data from previous pass to plan the next pass
- Automatically cut/strip from existing terrain
- Helps new operators perform like experienced ones

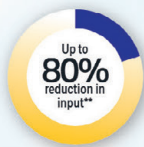

Tilt steering control

- Automatically tilts blade to maintain straight travel while rough dozing
- Maintains consistent power to the ground and track

Use automation throughout the entire process

Bidding

Stripping topsoil ①

Mass excavation ②

Finish grading ③



* Compared to previous iMC control methods

** Compared to traditional methods

PERFORMANCE FEATURES



KOMATSU NEW ENGINE TECHNOLOGIES

New Tier 4 Final Engine

The Komatsu SAA6D114E-6 engine is EPA Tier 4 Final emissions certified and provides exceptional performance while reducing fuel consumption. Based on Komatsu proprietary technologies developed over many years, this new diesel engine reduces nitrogen oxides (NOx) by more than 80% when compared to Tier 4 interim levels. Through the in-house development and production of engines, electronics, and hydraulic components, Komatsu has achieved great advancements in technology, providing high levels of performance and efficiency in virtually all applications.

Technologies Applied to New Engine

Heavy-duty aftertreatment system

This new system combines a Komatsu Diesel Particulate Filter (KDPF) and Selective Catalytic Reduction (SCR). The SCR NOx reduction system injects the correct amount of DEF at the proper rate, thereby decomposing NOx into non-toxic water (H₂O) and nitrogen gas (N₂).

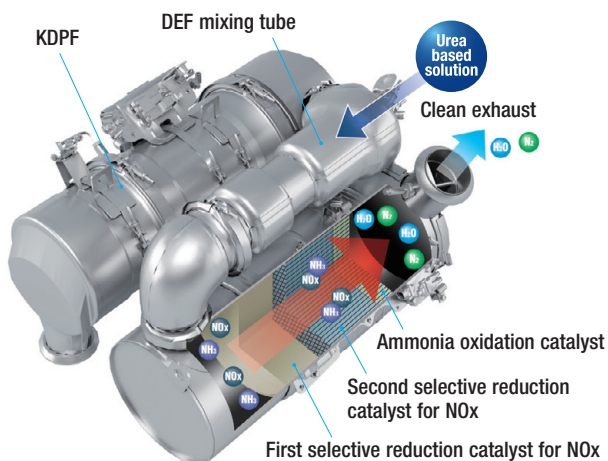
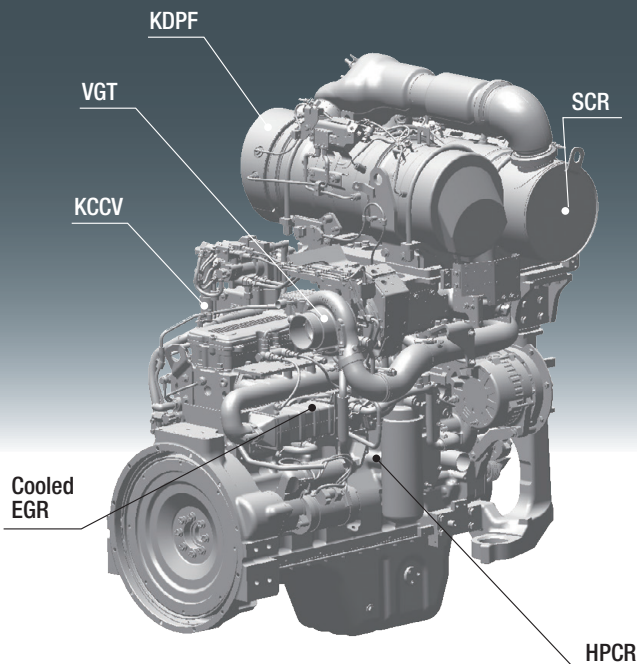

Advanced Electronic Control System

The electronic control system performs high-speed processing of all signals from sensors installed in the vehicle providing total control of equipment in all conditions of use. Engine condition information is displayed via an on-board network to the monitor inside the cab, providing necessary information to the operator. Additionally, managing the information via KOMTRAX helps customers keep up with required maintenance.

Variable Geometry Turbocharger (VGT) system

The VGT system features proven Komatsu design hydraulic technology for variable control of air-flow and supplies optimal air according to load conditions. The upgraded version provides better exhaust temperature management.

Heavy-duty cooled Exhaust Gas Recirculation (EGR) system

The system recirculates a portion of exhaust gas into the air intake and lowers combustion temperatures, thereby reducing NOx emissions. EGR gas flow has been decreased for Tier 4 Final with the addition of SCR technology. The system achieves a dynamic reduction of NOx, while helping reduce fuel consumption below Tier 4 Interim levels.

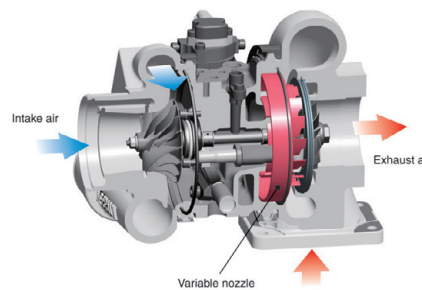
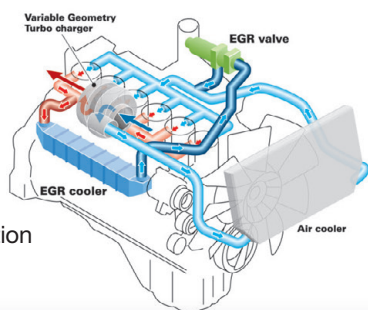

PERFORMANCE FEATURES

Komatsu Auto Idle Shutdown

Komatsu auto idle shutdown automatically shuts the engine down after idling for a set period of time to reduce unnecessary fuel consumption and exhaust emissions. The amount of time before the engine is shutdown can be easily programmed from five to 60 minutes.

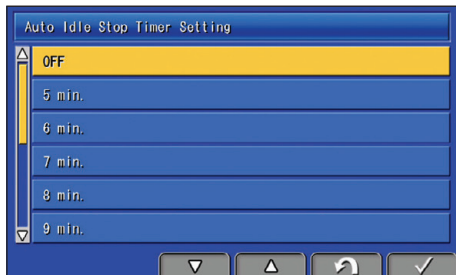

Secondary Engine Shutdown Switch

The secondary engine shutdown switch is located on the side of the front console.



Heavy-Duty High-Pressure Common Rail (HPCR) Fuel Injection System

The system is designed to achieve an optimal injection of high-pressure fuel by means of computerized control, providing close-to-complete combustion to reduce PM emissions. While this technology is already used in current engines, the new system uses high pressure injection, thereby reducing both PM emissions and fuel consumption over the entire range of engine operating conditions. The Tier 4 Final engine has advanced fuel injection timing for reduced fuel consumption and lower soot levels.

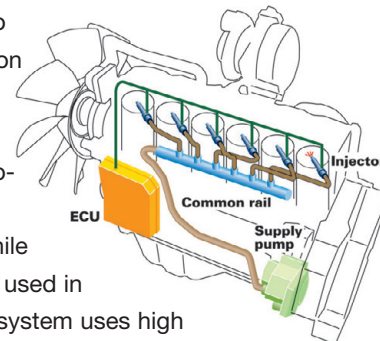

Hydraulically Driven Cooling Fan

The engine cooling fan speed is electronically controlled. The fan speed depends on engine coolant, powertrain oil and hydraulic oil temperatures. Higher temperatures create higher fan speed. The system increases fuel efficiency, reduces the operating noise levels and requires less horsepower than a belt driven fan. Operators can manually reverse the fan for periodic cleaning.



PRODUCTIVITY & FUEL ECONOMY FEATURES



- 1 Automatic transmission with lockup torque converter
- 2 KOMATSU SAA6D114E-6 engine
- 3 SIGMADOZER®

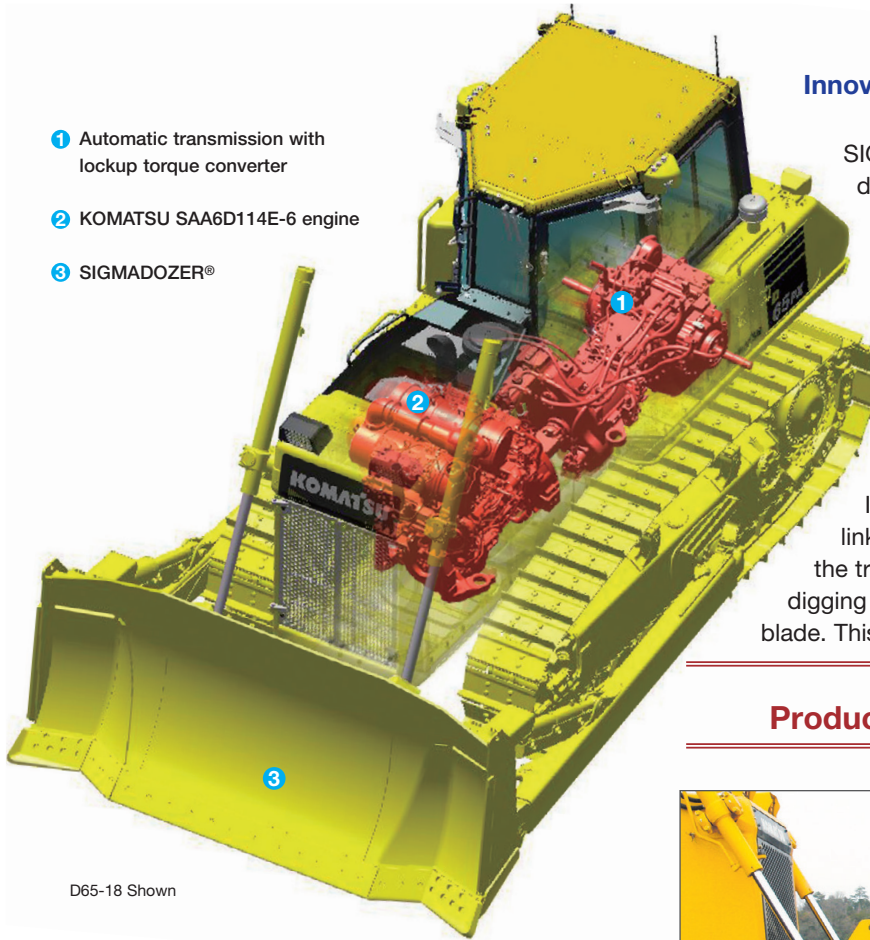

D65-18 Shown

Innovative SIGMADOZER® (optional)

Based on a completely new design, SIGMADOZER® dramatically improves dozing performance and increases productivity. A new frontal design concept adopted for digging and rolling up at the center of the blade increases soil holding capacity and simultaneously reduces sideway spillage. Reduced digging resistance produces smoother flow of material, enabling the dozing of larger quantities of material with less power. In addition, adoption of a new blade linkage system holds the blade closer to the tractor for improved visibility, enhanced digging force and reduced lateral sway of the blade. This is the next generation of dozer blades.

Production increased by 15%

Compared to conventional Semi-U blade



SIGMADOZER®



Semi-U blade

Innovative Fuel Efficient Bulldozer

The D65EX/EXi/PX/PXi/WX-18 achieves high levels of productivity with the SIGMADOZER® blade, automatic transmission with lockup torque converter and Tier 4 Final engine. The SIGMADOZER® blade, based on a completely new design theory, dramatically increases production. Also, this bulldozer significantly improves fuel efficiency compared with our conventional model.

SIGMADOZER®



Automatic transmission with lockup torque converter



Tier 4 Final engine



FUEL EFFICIENCY:

30% increase

Compared to machine with Semi-U blade and manual shift transmission

Production Increased By

15%

(compared with a conventional Semi-U blade model)

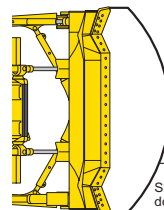

SIGMADOZER®

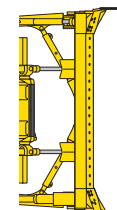

Semi-U blade

Shape of dozed material

Shape of dozed material

PRODUCTIVITY & FUEL ECONOMY FEATURES

Automatic Transmission with Lockup Torque Converter

The automatic gear shift transmission and lockup torque converter creates a sharp reduction in fuel consumption and greater power train efficiency. Travel speed is automatically selected depending on working conditions and load. This allows the machine to operate at maximum efficiency.

Operators can select manual shift mode with the flip of a switch.

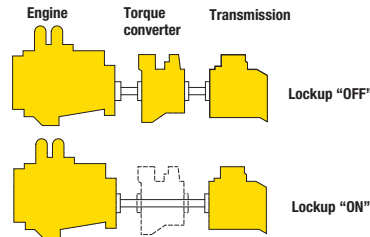

Fuel consumption reduced by 10%

Compared to machine with manual shift transmission

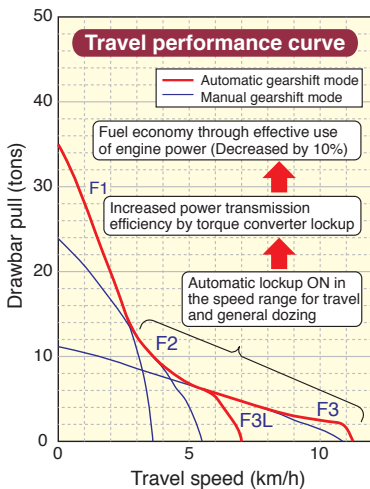

Lockup clutch of torque converter is automatically engaged to transfer engine power directly to the transmission in usual dozing speed range. Locking up the torque converter eliminates loss of horsepower by 10%. Because the electronically controlled engine is extremely efficient, a decrease in fuel consumption is realized while also maintaining machine power.

Selectable Working Mode

Working Mode P aims for powerful operation and maximum production. E Mode is for general dozing applications with adequate speed and power while saving fuel. The monitor panel allows the operator to switch the working mode with ease depending on the work at hand.

P Mode (Power mode)

With P mode, the engine outputs its full power, allowing the machine to perform large production, heavy-load and uphill work.

E Mode (Economy mode)

With E mode, the engine generates the power needed without delivering unnecessary power. The mode allows for fuel efficient operation and is best matched to work that may cause shoe slip and work not requiring maximum power, such as downhill dozing, leveling and light load work.

Automatic/Manual Gearshift Modes

Operators can select from two automatic and two manual gearshift modes to suit the work at hand. Change mode by simply pressing a monitor button. The selected shift mode remains saved at engine ignition key-off/key-on.

Auto shift torque converter lockup OFF

Newly added mode for heavy dozing. The transmission quickly upshifts and downshifts automatically to maximize productivity under the heaviest loads.

Auto shift torque converter lockup ON

General dozing mode to optimize fuel economy, the transmission upshifts and downshifts automatically based on load. Under certain conditions, the torque converter lockup clutch actuates to create a direct connection between the engine and tracks.

Manual shift auto-downshift ON

In this heavy dozing and ripping mode the transmission automatically shifts down to avoid overheating, but does not shift up when the load is off.

Manual shift auto-downshift OFF

When finish grading, this mode causes the transmission to remain in the selected travel gear until another gear is selected. Smooth and precise grading work can be achieved.

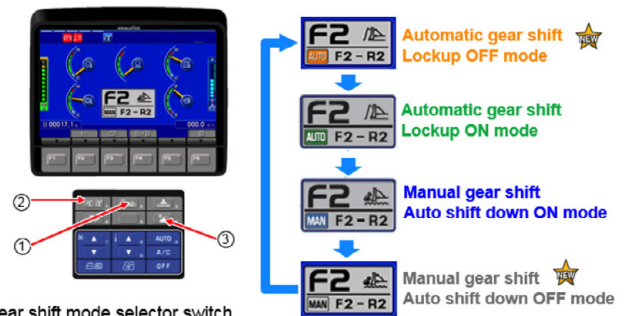

- ① Gear shift mode selector switch
- ② Working mode selector switch (P mode ↔ E mode)
- ③ Reverse slow mode selector switch

CONTROL FEATURES



Palm Command Electronic Controlled Travel Control Joystick

The palm command travel joystick allows the operator to adopt a relaxed posture and offers superb fine control without operator fatigue. Transmission gear shifting is simplified with thumb push buttons.

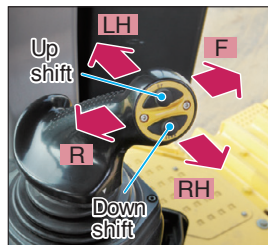

Travel Speed Preset Function

Forward and reverse travel speeds can be preset when the travel joystick is placed in neutral. Available F-R preset patterns are shown in the diagram below. The transmission automatically shifts to the preset gear when the travel lever moves to the Forward or Reverse position, thereby avoiding repeated manual upshifts and operator fatigue.



Automatic gearshift mode	Manual gearshift mode
F1-R1 MODE Press DOWN switch ↑ ↓ Press UP switch	F1-R1 MODE Press DOWN switch ↑ ↓ Press UP switch
F1-R2 MODE Press DOWN switch ↑ ↓ Press UP switch	F1-R2 MODE Press DOWN switch ↑ ↓ Press UP switch
F2-R1 MODE Press DOWN switch ↑ ↓ Press UP switch	F2-R1 MODE Press DOWN switch ↑ ↓ Press UP switch
F2-R2 MODE Press DOWN switch ↑ ↓ Press UP switch	F2-R2 MODE Press DOWN switch ↑ ↓ Press UP switch
F2-R3L MODE Press DOWN switch ↑ ↓ Press UP switch	F2-R3 MODE
F3L-R3L MODE	

Electronic Controlled Modulation Valve (ECMV) Controlled Transmission and Brakes

Controller automatically adjusts each clutch shift depending on travel conditions, providing smooth shockless clutch engagement, improved component life and operator ride comfort.

Enhanced Hydrostatic Steering System (HSS) -Smooth, Powerful Turning

Engine power is transmitted to both tracks as the dozer turns. Steering power has been increased 25% by a larger HSS motor, increased hydraulic pump flow, and increased engine horsepower while steering. The result is quicker, tighter turns and improved counter-rotation.



WORKING ENVIRONMENT



D65-18 Shown

Integrated ROPS Cab

The D65EX/EXi/PX/PXi/WX-18 cab meets:

ROPS standard ISO 3471:2008

FOPS Level 2 standard ISO 3449:2005

High rigidity and superb sealing reduces noise and vibration for the operator. The pressurized, climate controlled cab helps provide the operator with a fresh and clean working environment. Also, operators enjoy more side visibility because additional external ROPS posts are not required.



Comfortable Ride with Heated Seat

The operator seat features an air-suspension, lumbar support, a tilt adjust function and electric heater. The seat easily adjusts to fit operator shape and working conditions. Also the heated seat allows operators to work comfortably in the winter.

LED Lights

LED lights are equipped on of the machine. The visibility under low light environment is improved, and work at night with ease.



Rearview Monitoring System

The operator can view the rear of the machine on a color monitor. The camera can be synchronized with the travel lever to display rearview when in reverse.



Multifunction Audio

Has functions of AM/FM radio and AUX, USB and Bluetooth® wireless technology enabled products can be connected.



D65EX/EXi/PX/PXi/WX-18

RELIABILITY & MAINTENANCE FEATURES



Parallel Link Undercarriage System (PLUS)

Komatsu's innovative Parallel Link Undercarriage System features a rotary bushing that demonstrates high durability in any working condition. Allowing the bushing to rotate virtually eliminates bushing wear, resulting in doubled service life of the undercarriage when compared with the conventional undercarriage. In addition, wear limits of the link and carrier roller are increased to balance with the extended service life of the bushing.

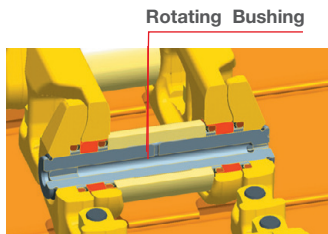

Self-adjusting Idler Support

The self-adjusting idler support provides constant and even tension on idler guide plates reducing noise and vibration and increasing undercarriage life.

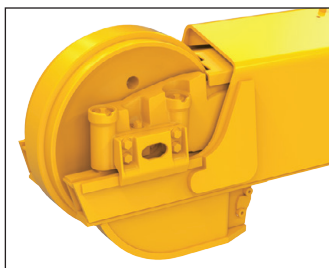

Oil Pressure Checking Ports

Pressure checking ports for power train components are centralized to promote quick and simple diagnosis.

Easy Sampling

New sampling ports for engine, hydraulic, and power line oil.

Wide Core Cooling System

In addition to improved engine compartment sealing, a wide core cooling system is standard. Radiator, oil cooler and charge air cooler use large square-wave fins spaced at 6 fins per inch. This allows more material to pass through, which helps self-cleaning and reduces maintenance.

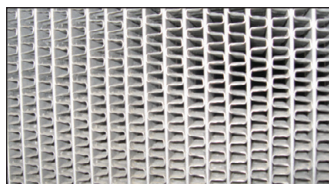

Equalizer Bar Side Pins

Remote grease nipple located on the outside of track-frame, so you can grease equalizer bar side pins easily.



Multi-Monitor with Troubleshooting Function to Minimize Down Time

Various meters, gauges and warning functions are centrally arranged on the multi-monitor. The monitor simplifies start-up inspection and promptly warns the operator with a lamp and buzzer if any abnormalities should occur. In addition, countermeasures are indicated in four levels to help prevent major problems. Replacement times for oil and filters are also indicated.



Maintenance

When the machine reaches the replacement interval for oil and filters, the monitor panel will display lights to inform the operator.

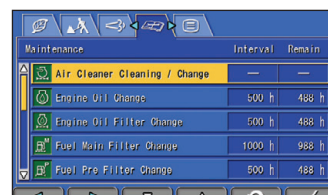

Battery Disconnect Switch with Lockout

A standard battery disconnect switch allows a technician to disconnect the power supply before servicing the machine.



Tie-offs

Anchor points of tie-off are installed. They are used to connect the safety belts of workers for maintenance and cleaning work.



KOMATSU PARTS & SERVICE SUPPORT



KOMATSU CARE®

Program Includes:

*The D65EX/EXi/PX/PXi/WX-18 comes standard with complimentary factory scheduled maintenance for the first 3 years or 2,000 hours, whichever comes first.

Planned Maintenance Intervals at:

500/1000/1500/2000 hour intervals. (250 hr. initial interval for some products) Complimentary Maintenance Interval includes: Replacement of Oils & Fluid Filters with genuine Komatsu Parts, 50-Point inspection, Komatsu Oil & Wear Analysis Sampling (KOWA) / Travel & Mileage (distance set by distributor; additional charges may apply).

Benefits of Using Komatsu CARE

- Assurance of Proper Maintenance with OEM Parts & Service
- Increased Uptime & Efficiency
- Factory Certified Technicians Performing Work
- Cost of Ownership Savings
- Transferable Upon Resale

Complimentary KDPF System Maintenance

The D65EX/EXi/PX/PXi/WX-18 comes standard with 2 Complimentary KDPF Exchange Units for the first 5 years at the suggested KDPF Exchange Units Service Intervals of 4,500 hours and 9,000 hours during the first 5 years. End User must have authorized Komatsu distributor perform the removal and installation of the KDPF.

Complimentary SCR System Maintenance

The D65EX/EXi/PX/PXi/WX-18 also includes 2 factory recommended services of the Selective Catalytic Reduction (SCR) Diesel exhaust fluid (DEF) system during the first 5 years—including:

- Factory recommended DEF tank flush and strainer cleaning at 4,500 hours and 9,000 hours

Komatsu CARE® – Advantage Extended Coverage

- Extended Coverage can provide peace of mind by protecting customers from unplanned expenses that effect cash flow
- Purchasing extended coverage locks-in the cost of covered parts and labor for the coverage period and helps turn these into fixed costs



Komatsu Oil and Wear Analysis (KOWA)

- KOWA detects fuel dilution, coolant leaks, and measures wear metals
- Proactively maintain your equipment
- Maximize availability and performance
- Can identify potential problems before they lead to major repairs
- Reduce life cycle cost by extending component life

KOMATSU CARE D65EX/EXi/PX/PXi/WX-18

Interval PM	500	1000	1500	2000
KOWA SAMPLING – (Engine, Hydraulics, L & R Final Drives)	✓	✓	✓	✓
LUBRICATE MACHINE	✓	✓	✓	✓
CHANGE ENGINE OIL	✓	✓	✓	✓
REPLACE ENGINE OIL FILTER	✓	✓	✓	✓
REPLACE FUEL PRE-FILTER	✓	✓	✓	✓
CLEAN FUEL STRAINER	✓	✓	✓	✓
REPLACE POWER TRAIN OIL FILTER	✓	✓	✓	✓
DRAIN FUEL TANK SEDIMENT	✓	✓	✓	✓
REPLACE A/C FRESH & RECIRCULATION FILTERS	✓	✓	✓	✓
CLEAN AIR CLEANER ELEMENT	✓	✓	✓	✓
COMPLETE 50 POINT INSPECTION FORM; LEAVE PINK COPY WITH CUSTOMER OR IN CAB	✓	✓	✓	✓
RESET MONITOR PANEL MAINTENANCE COUNTER FOR APPROPRIATE ITEMS	✓	✓	✓	✓
REPLACE FUEL MAIN FILTER		✓		✓
CHANGE POWER TRAIN OIL		✓		✓
CLEAN POWER TRAIN STRAINER		✓		✓
CLEAN SCAVENGING PUMP STRAINER		✓		✓
CHECK DAMPER CASE OIL LEVEL		✓		✓
CHANGE FINAL DRIVE OIL		✓		✓
REPLACE HYDRAULIC TANK BREATHER ELEMENT		✓		✓
REPLACE FUEL TANK BREATHER ELEMENT		✓		✓
REPLACE DEF TANK BREATHER ELEMENT		✓		✓
CLEAN POWER TRAIN CASE BREATHER		✓		✓
CHANGE HYDRAULIC OIL				✓
REPLACE HYDRAULIC FILTER				✓
CLEAN HYDRAULIC TANK STRAINER				✓
CHANGE DAMPER CASE OIL				✓
REPLACE KCCV FILTER				✓
REPLACE DEF FILTER				✓
FACTORY TRAINED TECHNICIAN LABOR	✓	✓	✓	✓
2 KDPF Exchanges at 4,500 Hrs and 9,000 Hrs.				
2 SCR System Maintenance Services at 4,500 Hrs. and 9,000 Hrs.				

Komatsu Parts Support

- 24/7/365 to fulfill your parts needs
- 9 parts Distribution Centers strategically located across the U.S. and Canada
- Distributor network of more than 300 locations across U.S. and Canada to serve you
- Online part ordering through Komatsu eParts
- Remanufactured components with same-as-new warranties at a significant cost reduction



* Certain exclusions and limitations apply. Refer to the customer certificate for complete program details and eligibility. Komatsu® and Komatsu Care® are registered trademarks of Komatsu Ltd. Copyright 2021 Komatsu America Corp.

D65EX/EXi/PX/PXi/WX-18

KOMTRAX EQUIPMENT MONITORING



GET THE WHOLE STORY WITH
KOMTRAX[®]

✓ **WHAT**

- KOMTRAX is Komatsu's remote equipment monitoring and management system
- KOMTRAX **continuously monitors and records** machine health and operational data
- Information such as fuel consumption, utilization, and a detailed history **lowering owning and operating cost**

✓ **WHEN**

- Know when your machines are **running or idling** and make decisions that will improve your fleet utilization
- Detailed movement records ensure you know when and where your equipment is moved
- Up to date records allow you to **know when maintenance is due** and help you plan for future maintenance needs

✓ **WHERE**

- KOMTRAX data **can be accessed virtually anywhere** through your computer, the web or your smart phone
- Automatic alerts keep fleet managers up to date on the latest machine notifications

✓ **WHO**

- KOMTRAX is **standard** equipment on all Komatsu construction products



✓ **WHY**

- Knowledge is power - **make informed decisions** to manage your fleet better
- Knowing your idle time and fuel consumption will help maximize your machine efficiency
- **Take control of your equipment** - any time, anywhere



KOMTRAX[®]

For construction and compact equipment.

KOMTRAX Plus[®]

For production and mining class machines.

SPECIFICATIONS



ENGINE

Model.....Komatsu SAA6D114E-6*
 Type..... 4-cycle, water-cooled, direct injection
 Aspiration.....Variable geometry turbocharged, air-to-air aftercooled
 Number of cylinders..... 6
 Bore x stroke..... 114 mm x 144.5 mm **4.49" x 5.69"**
 Piston displacement..... 8.85 ltr **540 in³**
 Governor.....All-speed and mid-range, electronic
 Horsepower
 SAE J1995..... Gross 164 kW **220 HP**
 ISO 9249 / SAE J1349.....Net 162 kW **217 HP**
 Rated rpm..... 1950 rpm
 Fan drive type..... Variable speed hydraulic
 Lubrication system
 Method..... Gear pump, force lubrication
 Filter..... Full-flow

**EPA Tier 4 Final emissions certified



TORQFLOW TRANSMISSION

Komatsu TORQFLOW transmission consists of a water-cooled, 3-element, 1-stage, 2-phase, torque converter with lockup clutch, and a planetary gear, multiple-disc clutch transmission, which is electronically controlled, hydraulically actuated and force-lubricated for optimum heat dissipation. Shift lock lever and neutral safety switch.

Travel speed	Forward	Reverse
1st	3.7 km/h 2.3 mph	4.5 km/h 2.8 mph
2nd	5.6 km/h 3.5 mph	6.7 km/h 4.2 mph
3rd L	7.3 km/h 4.5 mph	8.7 km/h 5.4 mph
3rd	11.3 km/h 7.0 mph	13.6 km/h 8.5 mph

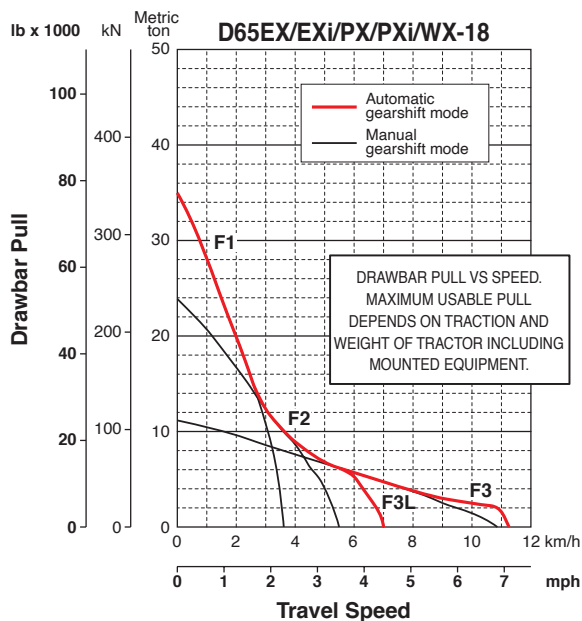

STEERING SYSTEM

Palm Command Control System (PCCS) lever controls for all directional movements. Pushing the PCCS lever forward results in forward machine travel, while pulling it rearward reverses the machine. Simply tilt the PCCS lever to the left for a left turns, tilt it right for right turns.

Hydrostatic Steering System (HSS) power has been increased 25% by a larger HSS motor, greater hydraulic pump flow, and more engine power while steering. The result is more powerful turns and quicker counter-rotation. Wet, multiple-disc, pedal-controlled service brakes are spring-actuated and hydraulically released. Gear shift lock lever also applies parking brake.

Minimum turning radius

D65EX-18.....	1.9 m 6'3"
D65EXi-18.....	1.9 m 6'3"
D65PX-18.....	2.2 m 7'3"
D65PXi-18.....	2.2 m 7'3"
D65WX-18.....	2.1 m 6'11"



UNDERCARRIAGE

Suspension..... Oscillating equalizer bar and pivot shaft
 Track roller frame..... Monocoque, large section, durable construction

Rollers and idlers..... Lubricated
 Track shoes

Parallel Link Undercarriage System (PLUS) with lubricated rotating bushings for extended system wear life and lower maintenance costs. Track tension is easily adjusted with a grease gun.

Tractor for outside mounted blade (Straight Tilt, Semi-U, SIGMADOZER®)*

	D65EX/EXi-18	D65PX/PXi-18	D65WX-18
Number of track rollers (each side)	7	8	7
Type of shoes (standard)	MS PLUS	MS PLUS	MS PLUS
Number of shoes (each side)	42	45	42
Grouser height	mm in 65 2.6"	65 2.6"	65 2.6"
Shoe width (standard)	mm in 610 24"	915 36"	760 30"
Ground contact area (ISO 16754)	cm ² 40910	66946	50969
	in ² 6,341	10,377	7,900
Ground pressure (tractor) (ISO 16754)	kPa 44.1	29.6	38.4
	kgf/cm ² 0.45	0.3	0.39
	psi 6.4	4.29	5.57
Track gauge	mm ft.in 1880 6'2"	2050 6'9"	2050 6'9"
Length of track on ground	mm ft.in 2970 9'9"	3275 10'9"	2970 9'9"

Tractor with inside mounted PAT blade (requires Waste Package)*

	D65PX-18
Number of track rollers (each side)	8
Type of shoes (standard)	ES PLUS clipped
Number of shoes (each side)	45
Grouser height	mm in 65 2.6"
Shoe width (standard)	mm in 760 30"
Ground contact area (ISO 16754)	cm ² 55605
	in ² 8,619
Ground pressure (tractor) (ISO 16754)	kPa 38
	kgf/cm ² 0.39
	psi 5.51
Track gauge	mm ft.in 2230 7'4"
Length of track on ground	mm ft.in 3275 10'9"

*See page 17 for tractor/blade combinations.

MS: Moderate Service shoe, ES: Extreme Service shoe, Clipped: Clipped grouser

D65EX/EXi/PX/PXi/WX-18



FINAL DRIVES

Double-reduction planetary gear final drives increase drawbar pull and reduce stresses for longer life. Segmented sprocket teeth are bolt-on for easy replacement. Triple labyrinth housing protects the final drive seals.



SERVICE REFILL CAPACITIES

Fuel tank	415 ltr	109.6 U.S. gal
DEF tank	23.5 ltr	6.2 U.S. gal
Coolant	49 ltr	12.9 U.S. gal
Engine.....	30.5 ltr	8.1 U.S. gal
Torque converter, transmission, bevel gear, and steering system	48 ltr	12.7 U.S. gal
Final drive (each side).....	27 ltr	7.1 U.S. gal



HYDRAULIC SYSTEM

Closed-center load sensing system (CLSS) designed for precise and responsive control, and for efficient simultaneous operation.

Hydraulic control units:

All spool valves externally mounted beside the hydraulic tank. Piston type hydraulic pump with capacity (discharge flow) of 248 ltr/min **65.5 U.S. gal/min** at rated engine rpm.

Relief valve setting 27.9 MPa 285 kg/cm² **4,050 psi**

Control valves:

Spool control valves for SIGMADOZER®, Semi-U, or straight tilt dozer

- Positions: Blade lift Raise, hold, lower, and float
- Blade tilt Right, hold, and left
- Rear attachment..... Raise, hold, and lower

Spool control valves for Power Angle Tilt dozer

- Positions: Blade lift Raise, hold, lower, and float
- Blade tilt Right, hold, and left
- Blade angle Right, hold, and left
- Rear attachment..... Raise, hold, and lower

Hydraulic cylinders..... Double-acting, piston

	Number of cylinders	Bore
		SIGMADOZER® Straight Tilt Dozer
Blade lift	2	85 mm 3.3"
Blade tilt	1	125 mm 4.9"
Blade angle	2	N/A
Ripper lift	1	125 mm 4.9"
Pitch angle	1	39° - 53°



DOZER EQUIPMENT

Blade capacities per SAE J1265. Moldboard constructed from high tensile abrasion resistant steel.

	Overall Length With Dozer mm ft.in	Blade Capacity m ³ yd ³	Blade Width x Height mm ft.in	Max. Lift Above Ground mm ft.in	Max. Drop Below Ground mm ft.in	Max. Tilt Adjustment mm ft.in	Weight Dozer Equipment kg lb	Ground Pressure** ISO 16754 kPa kg/cm ² psi
D65EX-18	5490	5.61	3410 x 1425	1135	500	870	2390	50.0/0.51/ 7.25
SIGMADOZER®	18'0"	7.34	11'2" x 4'8"	3'9"	1'8"	2'10"	5,260	
D65EX-18	5330	5.61	3470 x 1425	1105	430	870	2375	50.0/0.51/ 7.25
Semi-U Dozer	17'6"	7.34	11'5" x 4'8"	3'8"	1'5"	2'10"	5,236	
D65EXi-18	5490	5.61	3410 x 1425	1135	500	870	2390	50.0/0.51/ 7.25
SIGMADOZER®	18'0"	7.34	11'2" x 4'8"	3'9"	1'8"	2'10"	5,260	
D65EXi-18	5330	5.61	3470 x 1425	1105	430	870	2375	50.0/0.51/ 7.25
Semi-U Dozer	17'6"	7.34	11'5" x 4'8"	3'8"	1'5"	2'10"	5,236	
D65PX-18	5680	3.69	3970 x 1100	1130	535	890	2100	32.8/0.33/ 4.76
Straight Tilt Dozer	18'8"	4.83	13'0" x 3'7"	3'8"	1'9"	2'11"	4,630	
D65PX-18*	5790	4.42	4010 x 1235	1170	695	520	2990	40.8/0.42/ 5.91
Power Angle Tilt Dozer	19'0"	5.78	13'2" x 4'1"	3'10"	2'3"	1'8"	6,590	
D65PXi-18	5680	3.69	3970 x 1100	1130	535	890	2100	32.8/0.33/ 4.76
Straight Tilt Dozer	18'8"	4.83	13'0" x 3'7"	3'8"	1'9"	2'11"	4,630	
D65WX-18	5500	5.90	3580 x 1425	1135	500	770	2500	43.3/0.44/ 6.28
SIGMADOZER®	18'1"	7.72	11'9" x 4'8"	3'9"	1'8"	2'6"	5,510	

* PX PAT blade machine available only when ordered with waste package

**Ground pressure shows tractor, ROPS cab, full fluids, operator, standard equipment and applicable blade.

Ground pressure per ISO 16754

SPECIFICATIONS



DIMENSIONS — OUTSIDE MOUNTED DOZER BLADE

	D65EX-18 SIGMADOZER®	D65EXi-18 SIGMADOZER®	D65PX-18 Straight Tilt Dozer	D65PXi-18 Straight Tilt Dozer	D65WX-18 SIGMADOZER®
A	5490 mm 18'0"	5490 mm 18'0"	5680 mm 18'8"	5680 mm 18'8"	5500 mm 18'1"
B	1880 mm 6'2"	1880 mm 6'2"	2050 mm 6'9"	2050 mm 6'9"	2050 mm 6'9"
C	3160 mm 10'5" *	3330 mm 10'11"	3160 mm 10'5" *	3330 mm 10'11"	3160 mm 10'5" *
D	3085 mm 10'1"	3085 mm 10'1"	3085 mm 10'1"	3085 mm 10'1"	3085 mm 10'1"
E	2970 mm 9'9"	2970 mm 9'9"	3275 mm 10'9"	3275 mm 10'9"	2970 mm 9'9"
F	610 mm 24"	610 mm 24"	915 mm 36"	915 mm 36"	760 mm 30"
G	65 mm 2.6"	65 mm 2.6"	65 mm 2.6"	65 mm 2.6"	65 mm 2.6"
H	4065 mm 13'4"	4065 mm 13'4"	4370 mm 14'4"	4370 mm 14'4"	4065 mm 13'4"

*3350 mm **11'0"** is overall height if Komatsu sweeps are installed.

Ground clearance 415 mm **16"**

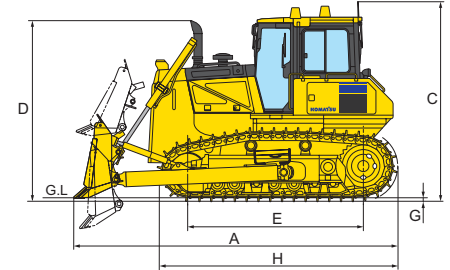
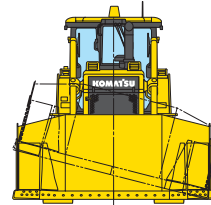
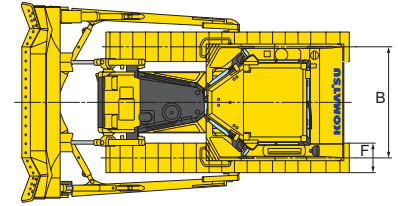

Shown with D65EXi-18 SIGMADOZER® single grouser shoe.



DIMENSIONS — PAT DOZER BLADE (requires Waste Package)

	D65PX-18 PAT Dozer
A	5790 mm 19'0"
B	2230 mm 7'4"
C	3160 mm 10'5" *
D	3085 mm 10'1"
E	3275 mm 10'9"
F	760 mm 30"
G	65 mm 2.6"
H	3627 mm 11'11"
I	4370 mm 14'4"

*3350 mm **11'0"** is overall height if Komatsu sweeps are installed.

Ground clearance 415 mm **16"**

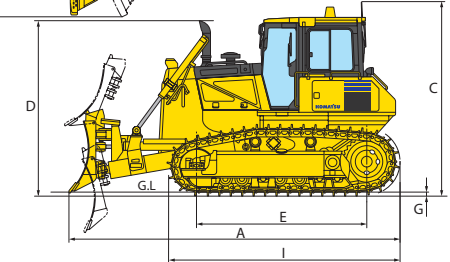
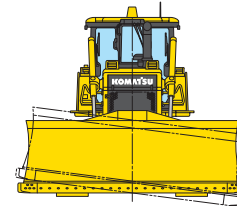
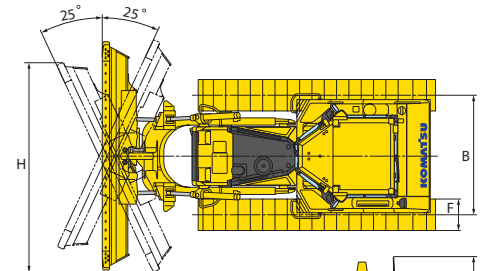

OPERATING WEIGHT

Tractor shipping weights:

Shipping weight includes blade lift cylinders (C-frame for PAT), ROPS cab, standard track, lubricants, coolant.

EX Sigmadozer/SU.....	18780 kg	41,403 lb
EXi Sigmadozer®.....	18780 kg	41,403 lb
WX Sigmadozer.....	20360 kg	44,886 lb
PX straight.....	20610 kg	45,437 lb
PXi Straight.....	20610 kg	45,437 lb
PX PAT.....	21950 kg	48,391 lb

Operating Weights:

Operating weight includes blade, hitch, ROPS cab, standard track, lubricants, coolant, full fuel tank, and operator.

EX Sigmadozer/SU.....	21270 kg	46,892 lb
EXi Sigmadozer®.....	21270 kg	46,892 lb
WX Sigmadozer.....	22960 kg	50,618 lb
PX straight.....	22830 kg	50,331 lb
PXi Straight.....	22830 kg	50,331 lb
PX PAT.....	23570 kg	51,963 lb

D65EX/EXi/PX/PXi/WX-18

EQUIPMENT



STANDARD EQUIPMENT FOR BASE MACHINE*

- Air cleaner, double element with dust indicator
 - Alternator, 90 ampere/24V
 - Auto idle shutdown function
 - Backup alarm
 - Batteries, 200 Ah/2 x 12V
 - Battery disconnect switch with lockout/tagout
 - Blade lift cylinders
 - Color monitor, LCD
 - Curved exhaust pipe
 - Decelerator pedal
 - Engine hood
 - Engine intake centrifugal precleaner
 - Engine, gull-wing side covers
 - Engine shutdown secondary switch
 - Fenders
 - Front pull hook
 - High mount foot rests
 - Horn, warning
 - Hydraulic driven radiator cooling fan with reverse clean mode
 - Hydraulics for rear equipment
 - KOMTRAX® Level 5
 - Komatsu Diesel Particulate Filter (KDPF)
 - Variable Geometry Turbocharger (VGT)
 - Locks, filler caps and covers
 - Oil pressure check ports for power train
 - Oil sampling ports for Engine, Trans, Hydraulics
 - Operator ID function
 - PM service connector
 - Radiator mask, heavy-duty, hinged, perforated
 - Rear cover
 - ROPS cab**
 - 75 dB operator ear noise level
 - Air conditioner with fresh air pre-cleaner
 - Cab accessories
 - 12V power supply (2 ports)
 - Cup holder
 - Rearview mirror
 - Rearview monitoring (1 camera)
 - Radio, Bluetooth/USB compatible
 - Shovel holder
 - Work lights, LED type
 - 2 front, hood mounted
 - 2 front, cab mounted
 - 1 rear, left fender mounted
 - 2 rear, cab mounted
 - Seat, air suspension, fabric, heated low back, rotates 12.5° to right, headrest
 - Seat belt, 76 mm **3"**, retractable
 - Seat belt indicator
 - Sealed electrical connectors
 - Secondary engine shutoff switch
 - Starting motor, 11.0 kW/24V
 - Steering system:
 - Hydrostatic Steering System (HSS)
 - Tie-off points standard ISO 14567
 - Torque converter with auto lock-up
 - Track roller guards, center and end sections
 - Track shoe assembly
 - Heavy-Duty lubricated rotary bushing (PLUS) track
 - 610 mm **24"** MS shoe (EX/EXi with outside mount blade)
 - 760 mm **30"** MS shoe (WX with outside mount blade)
 - 760 mm **30"** ES shoe (PX PAT requires Waste Package)
 - 915 mm **36"** MS shoe (PX/PXi with outside mount blade)
 - Transmission with auto/manual shift modes
 - Underguards, heavy duty
 - Hinged belly pan
 - Transmission
 - Water separator
 - Wide core cooling package
- * Dozer assembly and rear mounted equipment are not included in base machine standard equipment
- ** Cab meets OSHA/MSHA ROPS and FOPS Level 2 standards



OPTIONAL EQUIPMENT

- Dozer assembly
- Drawbar, long type
- Hitch
- Rear counterweight 850 kg **1,870 lb**
- Straight tilt frame for use with allied blades
- Track roller guard, full length
- Waste Package, available with EX semi-u, PX straight, PX PAT



Multi-shank ripper (for D65EX/EXi/WX-18)
 Weight..... 1920 kg **4,230 lb**
 Beam length..... 2170 mm **7'1"**
 Maximum lift above ground..... 640 mm **2'1"**
 Maximum digging depth..... 590 mm **1'11"**



ALLIED MANUFACTURER'S ATTACHMENTS (SHIPPED LOOSE)

- Guarding - Medford
 - Front sweeps (open top) 299 kg **660 lb**
 - Front sweeps (w/ top cover plate) 481 kg **1060 lb**
 - Hinged cab side screens 79 kg **175 lb**
 - Hinged cab rear screen 91 kg **200 lb**
 - Tank guards 404 kg **890 lb**
- Hydraulic winch - Allied H6H 1325 kg **2,900 lb**
- Mechanical angle blade - Rockland 1100 kg **2,425 lb**



All comparisons and claims of improved performance made herein are made with respect to the prior Komatsu model unless otherwise specifically stated.