

# CP2510

CP series

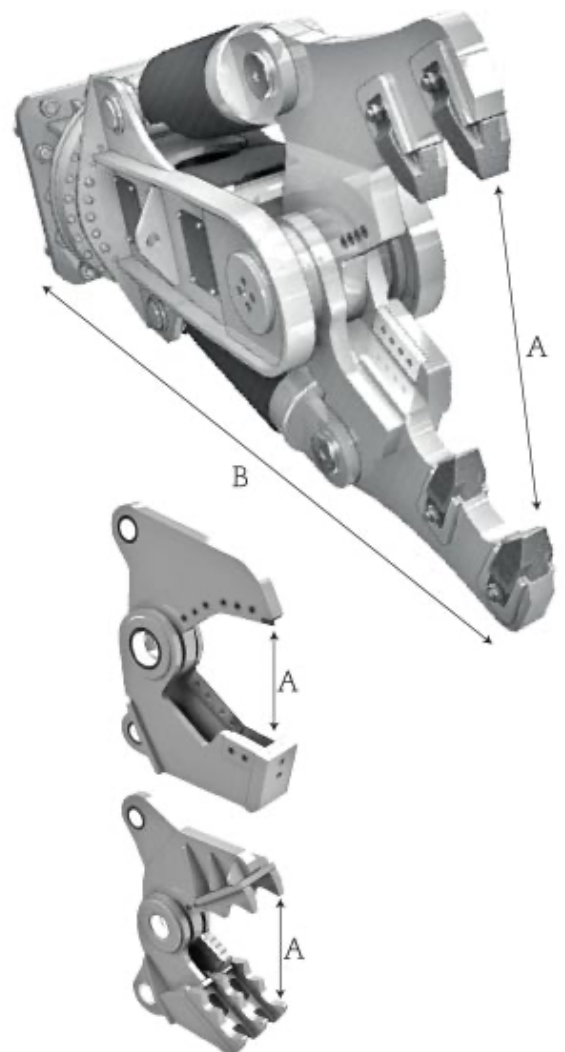

Working weight	2500 Kg
Excavator weight	25/35 ton
Cylinder force	115 t
Cylinders working pressure	350 bar
Cylinder oil flow	170/250 l/min
Rotation engine pressure	100 bar
Rotation oil flow (Min/Max)	10/15
Max jaws opening (A) PR	880 mm
Max jaws opening (A) SC	500 mm
Max jaws opening (A) FR	750 mm
Total height (B)	2650 mm
Rotation 360°	hydraulic



## Cutting data with SC jaws

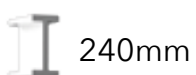

240mm



180mm



50mm